



CITADEL 1™ GASKETED ENCLOSURE

CT1

Kits and Individually Packed

Citadel 1™ The traditional damp and wet location enclosure for T5, T8 or T12 lamps. A strip fixture is mounted inside the fiberglass housing paired with an Acrylic impact resistant lens creating a weatherproof enclosure with easy to clean exterior surfaces. Inside the housing brass studs and knockouts match the strip KO locations.



Shallow Kit

- Shallow 2-1/2" (63,5mm) Lens
 - Injection Molded
 - Matte Stipple Finish
- 4ft and 8ft lengths
- Plastic Celcon Latches
- Studs on Center

CITADEL 1™ SHALLOW KITS

EACH KIT INCLUDES A LENS, HOUSING AND LATCH BAG

	DESCRIPTION	PART #
KITS (BULK)	4' HOUSING WITH 4' X 2.5" DEEP INJECTION MOLDED LENS	CT1-2L4-IM-2.5-KT
	8' HOUSING WITH 4' X 2.5" DEEP INJECTION MOLDED LENS	CT1-2L8-IM-2.5-KT
	4' HOUSING WITH 4' X 2.0" DEEP VACUUM FORMED LENS	CT1-2L4-VF-2.0-KT
Available in Increments of 30		
INDIVIDUALLY PACKED	4' HOUSING WITH INJECTION MOLDED LENS	CT1-2L4-IM-2.5-IP
	8' HOUSING WITH INJECTION MOLDED LENS	CT1-2L8-IM-2.5-IP
	4' HOUSING WITH 4' X 2.0" DEEP VACUUM FORMED LENS	CT1-2L4-VF-2.0-IP
2 ENDPLUGS PER LATCH BAG		

Deep Kit

- Deep 3" (76,2mm) Lens
 - Vacuum Formed
 - Matte Stipple Finish
- 4ft and 8ft lengths
- Plastic Celcon Latches

CITADEL 1™ DEEP KITS

EACH KIT INCLUDES A LENS, HOUSING AND LATCH BAG

	DESCRIPTION	PART #
KITS (BULK)	4' HOUSING WITH 4' X 3" DEEP VACUUM FORMED LENS	CT1-2L4-VF-3.0-KT
	8' HOUSING WITH 8' X 3" DEEP VACUUM FORMED LENS	CT1-2L8-VF-3.0-KT
Available in Increments of 30		
INDIVIDUALLY PACKED	4' HOUSING WITH 4' X 3" DEEP VACUUM FORMED LENS	CT1-2L4-VF-3.0-IP
	8' HOUSING WITH 8' X 3" DEEP VACUUM FORMED LENS	CT1-2L8-VF-3.0-IP
2 ENDPLUGS PER LATCH BAG		

Injection Molded Lens:

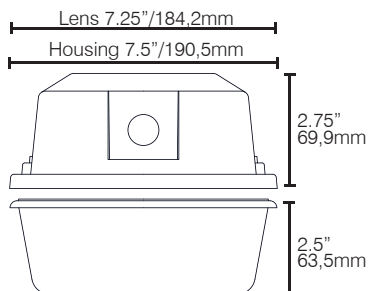

Vacuum Formed Lenses:

Shallow:

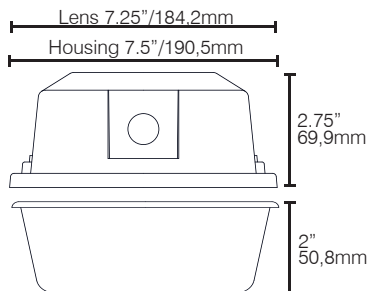

Deep:

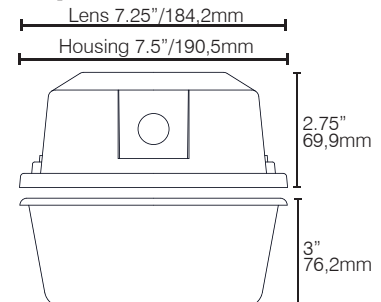

Product offering and specifications subject to change without notice.

SLP LIGHTING

PHONE: 636.600.4084 | 800.248.0224 FAX: 636.600.4108

www.slplighting.com V020112



CITADEL 1™ GASKETED ENCLOSURE

CT1

Components



Housing:

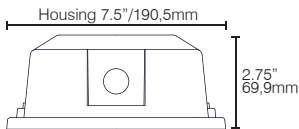

Injection Molded Lens:

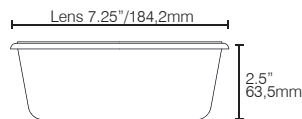

Vacuum Formed Lenses:

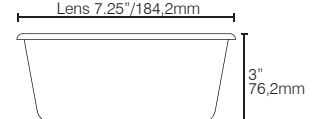
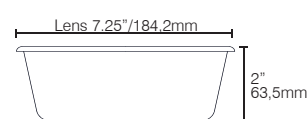

CITADEL 1™ HOUSINGS AND LENSES

	NOMINAL LENGTH	ACTUAL LENGTH	DEPTH	DESCRIPTION	MATERIAL	PART #
HOUSINGS	4'	49.875"	2.75"	BRASS STUD ON BACK	FIBERGLASS	CT1-HFWS-2L4
	8'	97.75"	2.75"	BRASS STUD ON BACK	FIBERGLASS	CT1-HFWS-2L8
LENSES	4'	49.875"	2.5"	INJECTION MOLDED	IMPACT RESISTANT ACRYLIC	CT1-DAIM-2.5-2L4-M
	8'	97.75"	2.5"	INJECTION MOLDED	IMPACT RESISTANT ACRYLIC	CT1-DAIM-2.5-2L8-M
	4'	49.875"	2"	VACUUM FORMED	IMPACT RESISTANT ACRYLIC	CT1-DAVF-2.0-2L4
	4'	49.875"	3"	VACUUM FORMED	IMPACT RESISTANT ACRYLIC	CT1-DAVF-3.0-2L4
	8'	97.75"	3"	VACUUM FORMED	IMPACT RESISTANT ACRYLIC	CT1-DAVF-3.0-2L8



CITADEL 1™ HARDWARE

	DESCRIPTION	PART #	PCS/CTN
LATCHES*	WHITE PLASTIC TOGGLE (1)	CT1-LP-W	
	STAINLESS STEEL (2)	CT1-LSS	
8 LATCHES ARE REQUIRED PER 4' HOUSING / 14 PER 8' HOUSING			
MOUNTING	EXTERNAL MOUNTING BRACKET (3)	CT1-MB-2L	1500
BUSHINGS (4)		CT1-DCB	200
ENDPLUGS (5)		CT1-P	300

Product offering and specifications subject to change without notice.

SLP LIGHTING

PHONE: 636.600.4084 | 800.248.0224 FAX: 636.600.4108

www.slplighting.com V020112